

EN

EP.V.35874.00 | 12.2023
EP.V.35857.00 | 12.2023

asecos®



ION
LINE

PRO
CORE

USER MANUAL

Safety storage cabinets for storage
and charging of lithium ion batteries

ION_{LINE}

ION-PRO-90



IO90.195.120.PC.WDC



IO90.195.120.PS.WDC

ION-CORE-90



IO90.195.060.CC.WDC



IO90.195.120.CS.WDC



IO90.195.060.CS.WDC



asecos GmbH
Customer service
Weierfeldsiedlung 16–18
D-63584 Gründau

Fax: +49 60 51 - 92 20-10
email: service asecos.com

YOUR PERSONAL DOCUMENTATION TO THE asecos SAFETY CABINET

Dear Customer,

you have made a decisive investment in safety for your company by purchasing this asecos safety storage cabinet. You now own an innovative product made of top-quality materials guaranteeing the highest quality standards.

asecos safety storage cabinets have complete authorisation documents. We archive the authorisation documents for every individual cabinet, keeping them ready for you should you ever need them (e.g. for a works inspection or similar). Simply request them using this form.

Tear of or copy that page and return to us by fax with your address and serial number of the cabinet on it.

Yours sincerely
asecos GmbH

Contact

Company		
<input type="text"/>		
Street	Postal code	Town
<input type="text"/>	<input type="text"/>	<input type="text"/>
Name of contact person		
<input type="text"/>		
email	Phone No.	
<input type="text"/>	<input type="text"/>	
Serial numbers of safety storage cabinets		
<input type="text"/>	<input type="text"/>	<input type="text"/>
<input type="text"/>	<input type="text"/>	<input type="text"/>
<input type="text"/>	<input type="text"/>	<input type="text"/>
<input type="text"/>	<input type="text"/>	<input type="text"/>

1. NOTES ▪ GUIDELINES ▪ GUARANTEE	5
1.1. General safety notes	5
1.2. Guarantee	5
1.3. Cabinet Details	5
2. TRANSPORT	6
2.1. Tilting the cabinet	6
2.2. Dismantling of the transport packaging	6
2.3. In-plant transport	7
2.4. Titling onto the side wall	7
3. INSTALLATION	7
3.1. Alignment Of The Cabinets	7
4. COMMISSIONING	8
4.1. ION-PRO-90: Connection to the power supply	8
4.2. ION-PRO-90: Self-test	9
4.3. ION-PRO-90: Installation of the extraction unit	9
4.4. ION-PRO-90: Potential-free alarm contact	9
4.5. ION-CORE-90: Potential-free alarm contact	10
5. CLOSING	10
5.1. In general	10
5.2. Locker System	10
6. INTERIOR FITTINGS	10
6.1. Bottom collecting sump	10
6.2. Shelves (height-adjustable)	11
6.3. Total power rating of the power socket strips	11
7. STORAGE	12
7.1. General information on batteries	12
7.2. Notes on storage and charging	12
8. VENTILATION ▪ PRESSURE RELIEF	12
8.1. Extraction unit (IO90.195.120.PC.WDC)	12
8.2. ION-PRO-90: Smoke detector	12
8.3. ION-CORE-90: Smoke detector	13
8.4. Pressure relief	13
9. ERROR ▪ FALSE ALARMS	13
9.1. Error during self-test	13
9.2. False alarm of the smoke detector	13
10. ALARM OVERVIEW	14
10.1. ION-PRO-90: Error and alarm overview	14
10.2. ION-CORE-90: Error and alarm overview	14
11. ION-PRO-90: WARNING/FIRE SUPPRESSION SYSTEM	14
11.1. Warning message	15
11.2. Alarm stage 1	15
11.3. Alarm stage 2	16
12. BATTERY FIRE ▪ EVENT OF FIRE ▪ DISPOSAL	16
12.1. Fire inside the cabinet (battery fire)	16
12.2. Opening the cabinet after the fire	17
12.3. Disposal	17
13. SAFETY CHECKS	17
13.1. All Models	17
13.2. ION-PRO-90	17
13.3. ION-CORE-90	17
13.4. ION-CORE-90: Smoke detector maintenance	18
13.5. Cleaning	18
13.6. Contact	18
14. TECHNICAL DATA	20
15. TECHNICAL DRAWING	20
15.1. ION-PRO-90	20
15.2. ION-CORE-90	21

1.1. GENERAL SAFETY NOTES

- When handling lithium-ion batteries, observe the applicable regulations and the information in these operating instructions
- Work on the electrical system is to be carried out only with the power turned off and only by qualified electricians – refer here to the regulations of the local electricity supply company.
- General damage to electronic components is to be repaired without delay by an asecos employee.
- Use only intact and undamaged mains cables for the battery charger
- Electrical protection in accordance with local standards must be provided by the customer (cabinets do not have their own RCD circuit breaker or circuit breaker)
- The on-site installation conditions are to be observed.
- The instructions of the supervisory engineering department must be followed.
- Observe accident prevention regulations and workplace ordinance
- **Ensure that the necessary safety checks are only carried out by authorised staff using original spare parts**
- Only use the cabinet after having been properly instructed; access is to be forbidden to unauthorised persons.
- The doors are permanently self-closing and must not be pushed shut manually
- The pivoting area of the doors is to be kept free at all times; doors are to be kept closed
- By assigning trained/authorised technical personnel you can prevent the malfunctions, damage and corrosion damage that result from inappropriate transport.
- Observe the upper limits for stored quantities, loading etc.
- The following substances may not be stored in the cabinets with a fire suppression system: acids, alkalis, magnesium, other metals (in powder form)
- **Observe the notes on maximum size and general storage of the batteries in these instructions**

Set-up requirements

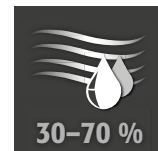
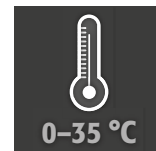

1.2. GUARANTEE

The guarantee for this product is agreed between you (the customer) and your dealer (the seller). As the manufacturer, asecos guarantees the products listed in the operating instructions for a period of 24 months from the date of delivery. All model safety equipment are subject to a compulsory annual inspection by specialised staff authorised by the manufacturer. Otherwise the customer's guarantee claim against the manufacturer expires. Please note that the warranty is also void if holes are drilled or modifications are made without consulting the manufacturer asecos.

1.3. CABINET DETAILS

Cabinet data: logbook (included with the cabinet)
Technical drawing: see appendix
Technical data: table in appendix

ION-CORE-90

Safety storage cabinets for lithium-ion batteries

Comprehensive fire protection with the proven evacuation and alarm forwarding concept. During active storage, lithium-ion batteries or battery packs are charged or partially discharged (60-70%) in the cabinet using a charger.

ION-PRO-90

Safety storage cabinets for lithium-ion batteries

Extended protection for professional handling of lithium-ion batteries including 3-stage alarm and active fire suppression system. During active storage, lithium-ion batteries or battery packs are charged or partially discharged (60-70%) in the cabinet using a charger.

Model	Lithium ion batteries		Integrated ventilation	Fire suppression unit	Alarm system
	Storing	Charging			
ION-CORE-90					
IO90.195.060.CC.WDC	✓	✓			✓
IO90.195.120.CS.WDC	✓				✓
IO90.195.060.CS.WDC	✓				✓
ION-PRO-90					
IO90.195.120.PC.WDC	✓	✓	✓	✓	✓
IO90.195.120.PS.WDC	✓			✓	✓

2. TRANSPORT

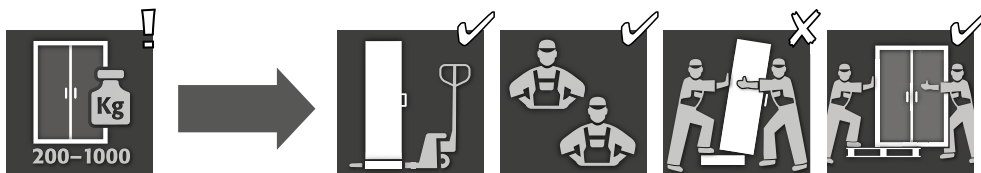

CAUTION:

Transport the cabinet in an upright position on a pallet truck, tied and secured against slipping, until the final place of installation is reached. The transport locks in the door joints may only be removed directly at the place of installation! Inappropriate transport can lead to concealed damage to the fire protection insulation! We can only guarantee the necessary quality if the cabinet is transported to the place of its use by our specially trained staff.



ATTENTION with cabinets including extraction unit:

The doors must be locked prior to transport! The extraction unit is inside the cabinet and is only mounted after the in-plant transport to the place of use.

2.1. TILTING THE CABINET



CAUTION:

Tilting the cabinet may only be done without jolts!

2.2. DISMANTLING OF THE TRANSPORT PACKAGING

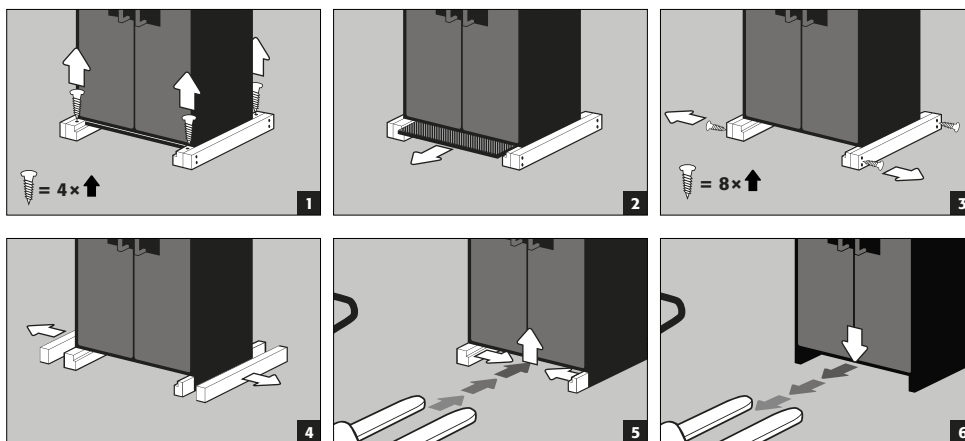

CAUTION:

Cabinets with a width of 600 mm: The clear entry width of the base is 520 mm. Please note this when choosing your pallet truck! Devices with widths greater than the entry widths must not be used.

2.3. IN-PLANT TRANSPORT

- In-plant transport is also possible without transport locks (inserted as standard in the door joints)



ATTENTION with cabinets including extraction unit:
The doors must be locked prior to transport! The extraction unit is inside the cabinet and is only mounted after the in-plant transport to the place of use.

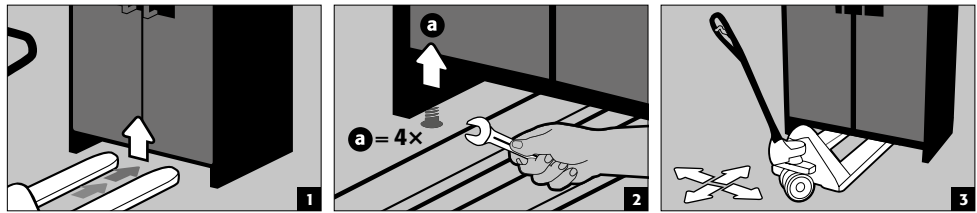

2.4. TITLING ONTO THE SIDE WALL

- Titling onto the side wall is only possible with the optionally available tilting bracket (order no. 29556).

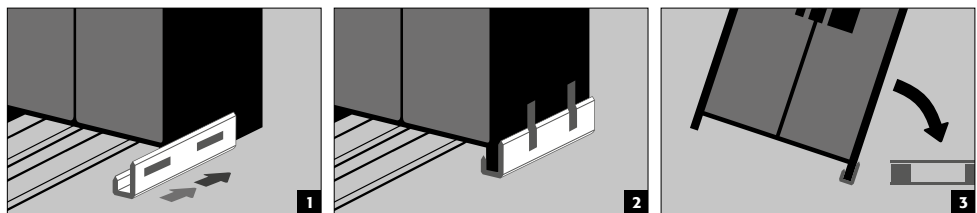

3. INSTALLATION

3.1. ALIGNMENT OF THE CABINETS

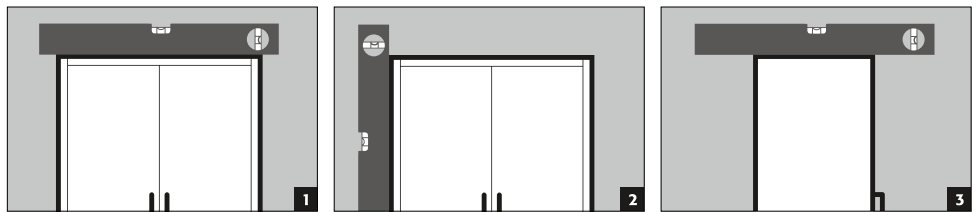
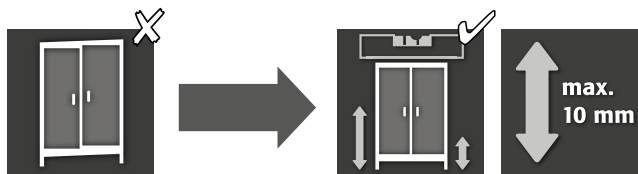

CAUTION:
Door elements must not scrape against the fire prevention seals in the fold of the door when opening and closing! Doors with an automatic closing mechanism must close automatically from every position and the lock must be able to lock!

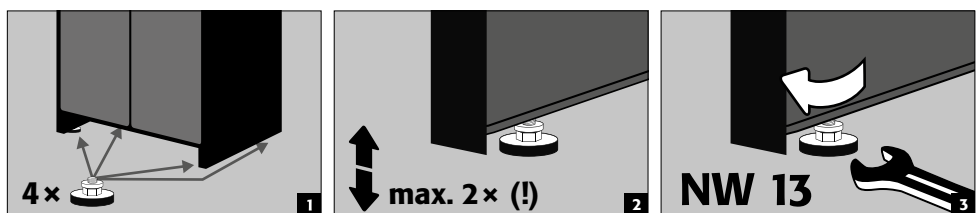

4. COMMISSIONING

- Before putting into operation for the first time, the user must carry out an examination of the safety storage cabinet for possible damage, such as defective or loose sealing elements, correct alignment and perfect functioning of the door elements.
Use the cabinet and accessories only if they are in an orderly condition.

4.1. ION-PRO-90: CONNECTION TO THE POWER SUPPLY

Connections on the headpiece:

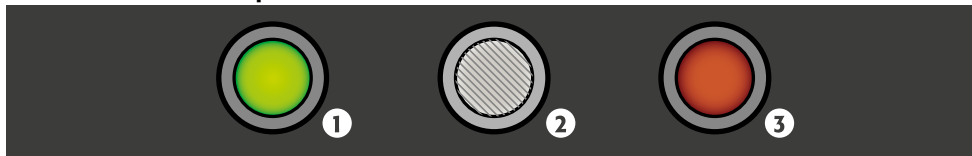

1 LED: Operating (green) 2 RESET BUTTON 3 LED: Error (red)

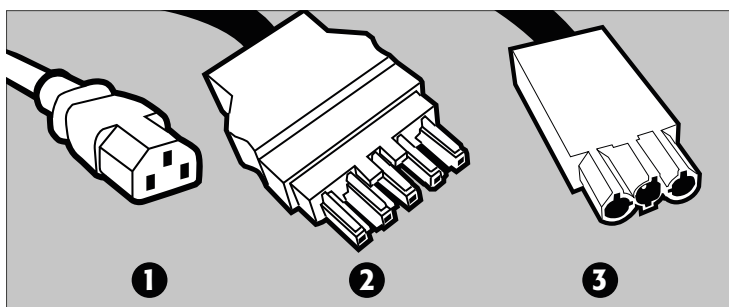

1 Mains connection for extraction unit (IO90.195.120.PC.WDC)
2 Mains plug connector
3 Potential-free switch contact

Connection to the power supply

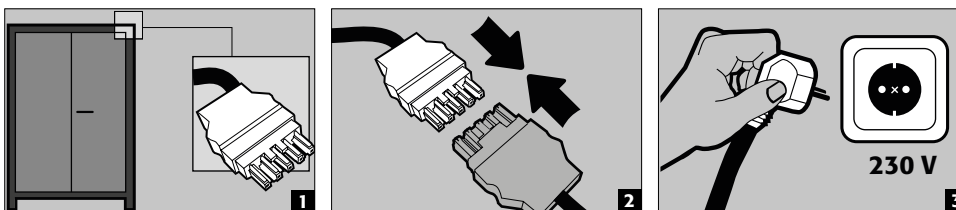

Connection to the power supply with 400 V (optional with item 38038)

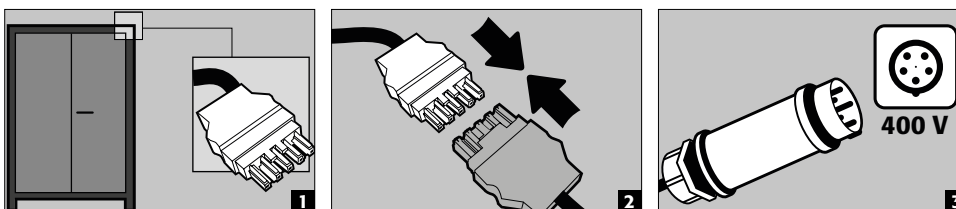

NOTE:

Retrofitting is easy due to the plug-in connection, so that no intervention in the electrical components is necessary. The power supply must be fused on site with a maximum of 16A

4.2. ION-PRO-90: SELF-TEST

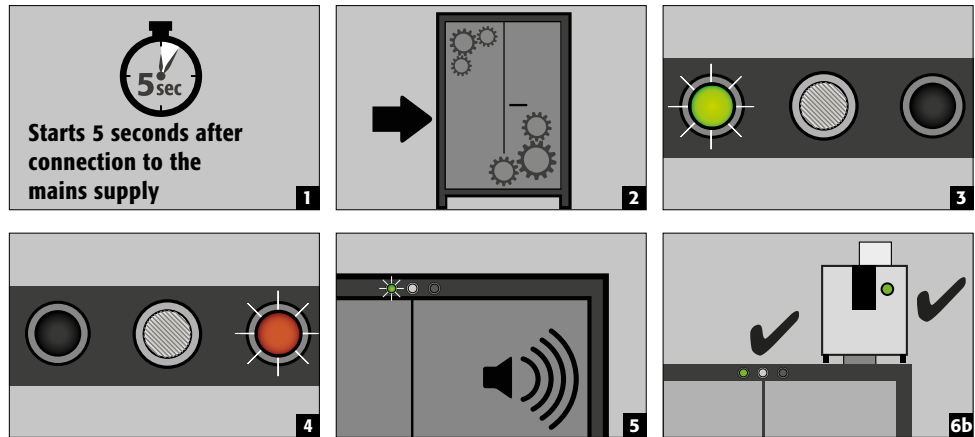

4.3. ION-PRO-90: INSTALLATION OF THE EXTRACTION UNIT

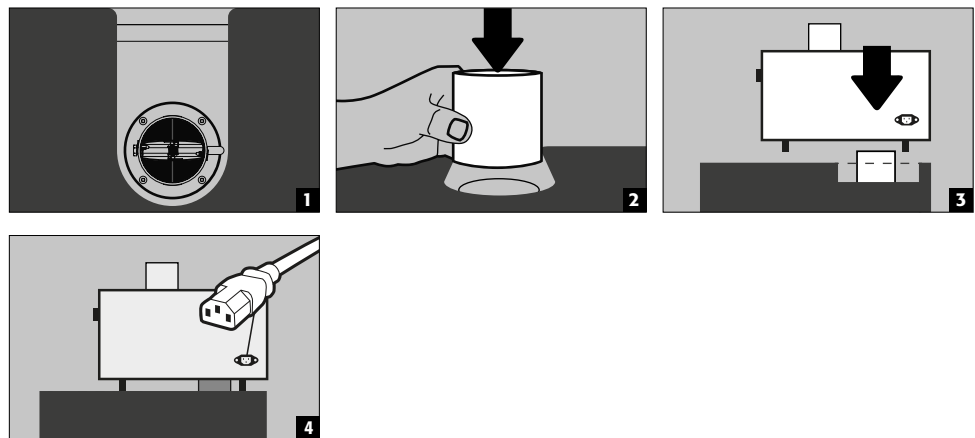

4.4. ION-PRO-90: POTENTIAL-FREE ALARM CONTACT



NOTE:

The potential-free alarm contact is used to connect a signal to a control centre/control room. Direct integration into a fire alarm control panel (FACP) is not recommended or may only be carried out in consultation with the person responsible for the system.

However, it is always recommended to connect the signal to a manned control centre/control room!

The potential-free switching contact must always be connected by the customer (not a service).

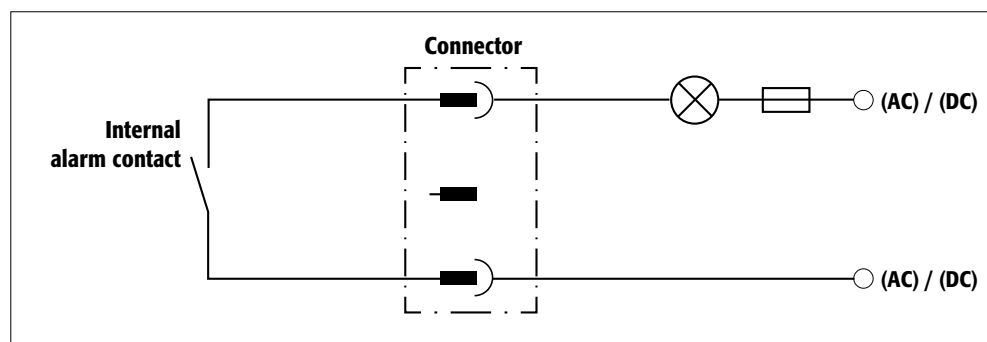

Connection instructions

- Use only the supplied mating part (colour-coded black) to the plug for the connection
- The connection must be done by a qualified electrician
- The contact is designed for a max. DC voltage of 30 V or a max. AC voltage of 230 V
- The maximum current load is 10 A
- The switch contact is normally closed!
- The switch contact opens as soon as mains voltage is present and no error is pending (device is „ready to operate“)

4.5. ION-CORE-90: POTENTIAL-FREE ALARM CONTACT



NOTE:

The potential-free alarm contact is used to connect a signal to a control centre/control room. Direct integration into a fire alarm control panel (FACP) is not recommended or may only be carried out in consultation with the person responsible for the system.

However, it is always recommended to connect the signal to a manned control centre/control room!

The potential-free switching contact must always be connected by the customer (not a service).

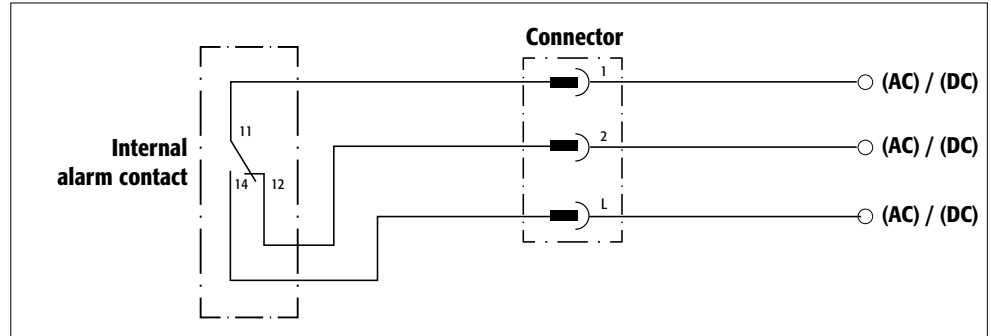

Connection instructions

- Use only the supplied mating part (colour-coded brown) to the plug for the connection.
- The connection must be done by a qualified electrician.
- The internal switch contact is designed for a max. DC voltage of 24 V or a max. AC voltage of 230 V.
- The maximum current load is 5 A at 230 V AC and 10 A at 24 V DC.
- The internal switch contact is a changeover contact; in case of alarm, therefore, the switching state may be queried as „opened“ or „closed“.

5. CLOSING

5.1. IN GENERAL

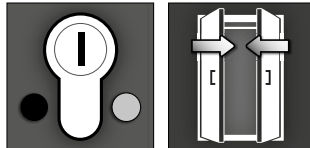

The doors are permanently self-closing and self-locking. They must not be closed manually. The cabinets have a profile cylinder lock with locking status indicator and can be integrated into a locking system. A profile half cylinder (30/10) with adjustable cam must be used.



ATTENTION:

The owner/user must ensure that all doors are kept closed whenever the contents of the cabinet are not being accessed. In general, it must be noted that the cabinets do not possess an emergency unlocking facility. This means that persons trapped inside the cabinet cannot free themselves!

5.2. LOCKER SYSTEM

- Lockers can be closed manually and each has a cylinder lock with its own key pair
- An additional master key opens all 7 lockers
- Lockers and keys can be individually numbered using the key ring set and sticker sheet provided

6. INTERIOR FITTINGS

6.1. BOTTOM COLLECTING SUMP

Leaks:

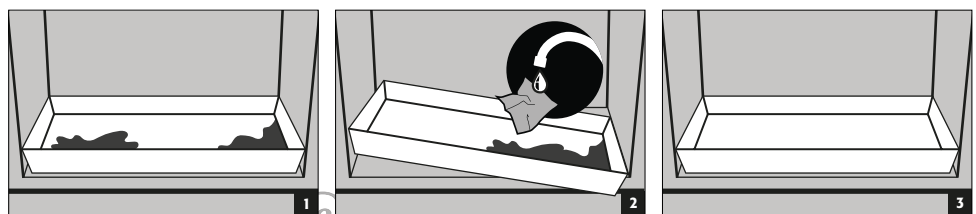

- Liquid in the sump is to be collected using suitable means.
- The choice of means is your own responsibility.

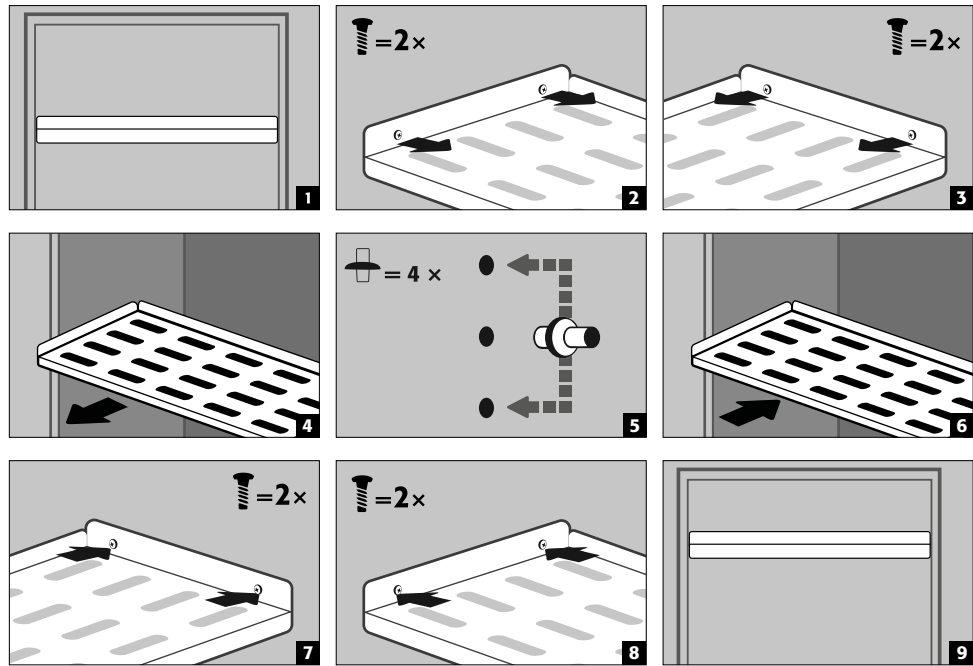

6.2. SHELVES (HEIGHT-ADJUSTABLE)



LOAD CAPACITY (KG/ DRUM PLATFORM)

IO90.195.120.PC.WDC IO90.195.120.PS.WDC IO90.195.120.CS.WDC	IO90.195.060.CC.WDC IO90.195.060.CS.WDC
 max. 75 kg	 max. 25 kg



CAUTION:

Please note that dynamic forces act when loading the cabinets. Always place batteries carefully in the cabinet!



CAUTION:

The position of the shelves / 2nd level drawer and socket strips cannot be changed.

6.3. TOTAL POWER RATING OF THE POWER SOCKET STRIPS

Standard: single-phase, 230 V

Version	EU	CH	UK	FR	other regions:
fusing	16 A	10 A	13 A	16 A	Please get in touch with your asecos contact person. The maximum power and protection may differ here.
max. total power	3,68 kW	2,3 kW	2,99 kW	3,68 kW	

Optional: 3-phase, 400 V (accessories article 38038)

Note on model with a width of 600 mm IO90.195.060.CC.WDC: Only 2 of the 3 connected phases are required by the cabinet electronics. The third phase remains unused.

Version	EU	CH	UK	FR	other regions:
fusing	3 x 16 A	3 x 10 A	3 x 13 A	3 x 16 A	Please get in touch with your asecos contact person. The maximum power and protection may differ here.
max. total power	11,04 kW	6,9 kW	8,97 kW	11,04 kW	



ATTENTION:

The load on the system is to be distributed as evenly as possible over the power socket strips! The individual power strip must not be loaded with more than the specified power max. (see table)!

The necessary fuse protection is to be provided by the customer!

7. STORAGE

7.1. GENERAL INFORMATION ON BATTERIES



ATTENTION:

Never store obviously damaged lithium-ion batteries inside buildings. Dispose of them without delay in disposal containers that are provided outside the building and approved for transport.



CAUTION

Only batteries with a maximum output of 2 kW and a maximum weight of 15 kg may be stored in the cabinets.

7.2. NOTES ON STORAGE AND CHARGING

Storage

- It is recommended to store new and used lithium-ion batteries separately (each on a different storage level) in the safety storage cabinet.

Occupation of the storage levels (IO90.195.XXX.XX.WDC)

Grid shelves may be covered only up to 60% by battery chargers and batteries in order to ensure trouble-free operation of the fire suppression system and sufficient air circulation.



CAUTION:

Full-surface occupancy of the storage levels is not permitted.

ION-PRO-90:

The following substances must not be stored in the cabinets with fire suppression system:

Acids, bases, magnesium, other metals (in powder form).

Heat is generated during the charging of a lithium-ion battery!

Please note: The technical ventilation (to avoid heat accumulation in the interior) needs to be kept in operation permanently.

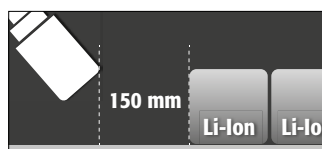

CAUTION:

A distance of min. 150 mm must be maintained in the area in front of the fire suppression unit.

8. VENTILATION - PRESSURE RELIEF

8.1. EXTRACTION UNIT (IO90.195.120.PC.WDC)

- See point 4.4 for the installation. The green indicator lamp signals that the fan is switched on.



ATTENTION:

Heat is generated during the charging of a lithium-ion battery!

Please note:

The technical ventilation (for the avoidance of heat accumulation in the interior) must run continuously. Repairs to the extraction unit are only to be carried out by specialists specifically trained for this. Given damage the appliance is to be repaired or replaced by the manufacturer.

8.2. ION-PRO-90: SMOKE DETECTOR



ATTENTION:

The complete warning/fire suppression system is active only with mains operation. The integrated smoke detector is part of the entire fire suppression system (direct power supply).

8.3. ION-CORE-90: SMOKE DETECTOR

These models have a battery-operated smoke detector.

Battery change



CAUTION:
The use of rechargeable batteries is not permitted!
The life of the battery is highly dependent on local conditions such as temperature, temperature fluctuations, humidity and the number of test alarms/alarms, among other things. In the case of lithium, this is up to 5 years. The smoke detector announces a necessary battery change approx. 30 days in advance (see 10.2).

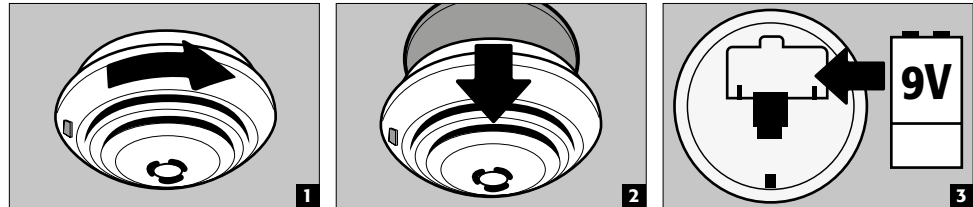

8.4. PRESSURE RELIEF

All ION-LINE models have a pressure relief flap built into the head section, which opens briefly in the event of a pressure increase and thus releases the pressure from the cabinet.

9. ERROR - FALSE ALARMS

9.1. ERROR DURING SELF-TEST

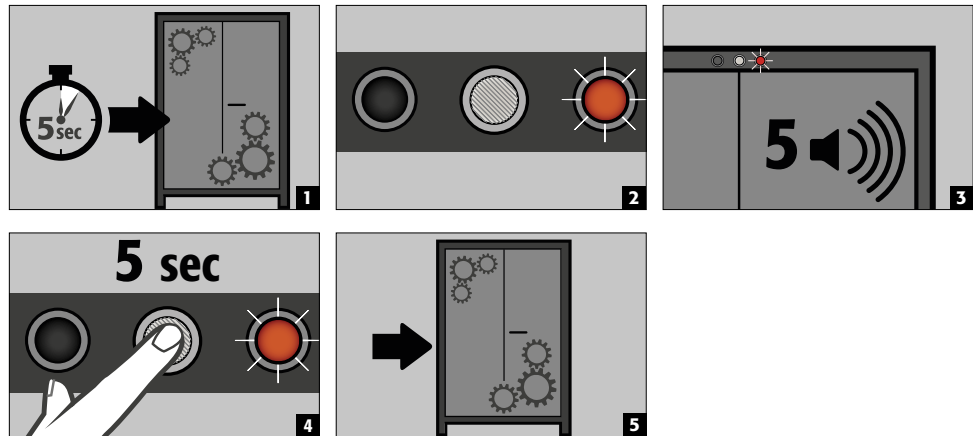

ATTENTION:
After pressing the reset button, the self-test begins again. If the error persists, please contact the asecos Service department.

9.2. FALSE ALARM OF THE SMOKE DETECTOR

- By interrupting the power supply for a few seconds, the smoke detector is reset and the system returns to normal operation.

10. ALARM OVERVIEW

10.1. ION-PRO-90: ERROR AND ALARM OVERVIEW

EVENT	LED GREEN	LED RED	ACOUSTIC ALARM	ACTIONS
Error during self-test	off	turned on	5 signal tones	1.) Restart with RESET button if error persists: 2.) Contact Service
Service interval reached	flashing	off	off	Contact Service
Power failure	off	Flashes every 20 seconds	3 short signal tones every 60 seconds	Check power supply
Warning message: Temperature in the cabinet >50 °C	off	turned on	Tone interval (every 2 seconds for 250 ms)	see 11.1
Alarm stage 1: Smoke detector detects smoke in the cabinet	off	turned on	medium tone interval (every 0.5 seconds for 250 ms)	see 11.2
Alarm stage 2: Smoke detector detects smoke in the cabinet, Temperature in the cabinet >70 °C	off	flashing	fast tone interval (every 0.25 seconds for 125 ms)	see 11.3

10.2. ION-CORE-90: ERROR AND ALARM OVERVIEW

EVENT	LED RED ON SMOKE DETECTOR	ACOUSTIC ALARM	ACTIONS
Smoke detector detects smoke in the cabinet	flashing	pulsating alarm tone	see 12.1
Triggered by connected detectors	off	pulsating alarm tone	The triggering detector can be identified by parallel to the alarm tone flashing LED
Battery replacement due	flashing	short beep every 45 seconds	see 8.3
Operational readiness	flashes every 45 seconds	off	
Malfunction	flashes alternately with the beep	short beep every 45 seconds	change smoke detector

11. ION-PRO-90: WARNING/FIRE SUPPRESSION SYSTEM

- The warning/fire suppression system offers the option of connection to a constantly manned building management system or fire alarm centre.
- Make use of this option so that trained rescue personnel can be quickly alerted and be on-site in a very short time and, following an initial assessment of the situation, immediately initiate further measures (for example, transporting the cabinet out of the building).
- In this way consequential damage to the building and personal injuries can be avoided.
- The extinguishing agent, based on potassium carbonate, is harmless in the necessary extinguishing agent concentration and has no harmful effects on the human organism.
- In case of triggering, the aerosol is ejected at a high temperature and temperatures of over 300 °C are briefly generated in front of and on the housing of the fire suppression cartridge (according to the manufacturer's data, a minimum distance to combustible materials need not be maintained; however, a distance of at least 150 mm to the fire suppression cartridge should generally be maintained).
- After triggering of the fire suppression cartridge, ventilate the room and the cabinet well, observing the instructions in **point 12**.



ATTENTION:

The complete warning/fire suppression system is active only with mains operation. The integrated smoke detector is part of the entire fire suppression system (direct power supply).

11.1. WARNING MESSAGE

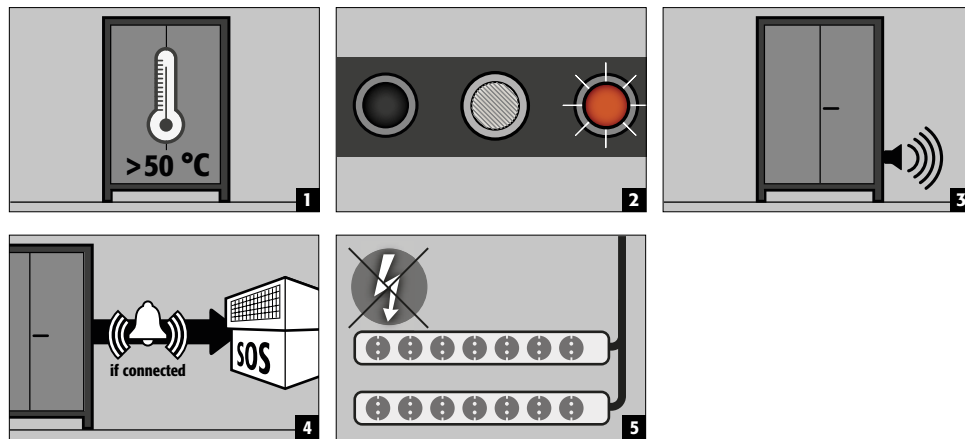

- Actions**
 Immediate visual inspection of the system by the company's own qualified personnel.
 Initiation of necessary actions.
 If the interior temperature falls below 50 °C, the system returns to normal operation and the visual and acoustic signals are switched off.

11.2. ALARM STAGE 1

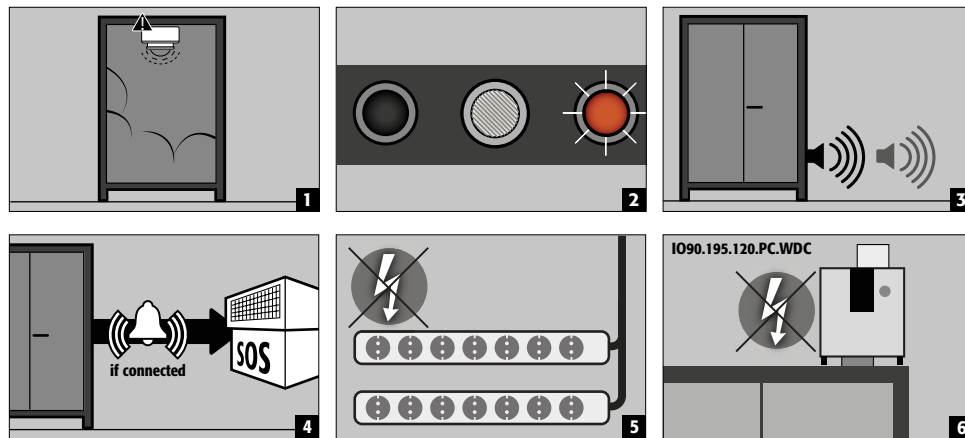

- Actions**
 Immediate visual inspection of the system **by technical personnel (e.g. fire brigade)**.
 Subsequently, initiation of necessary actions.
 If the smoke detector does not detect any further smoke development in the cabinet, the system can be reset to normal operation by briefly disconnecting the mains voltage.

11.3. ALARM STAGE 2

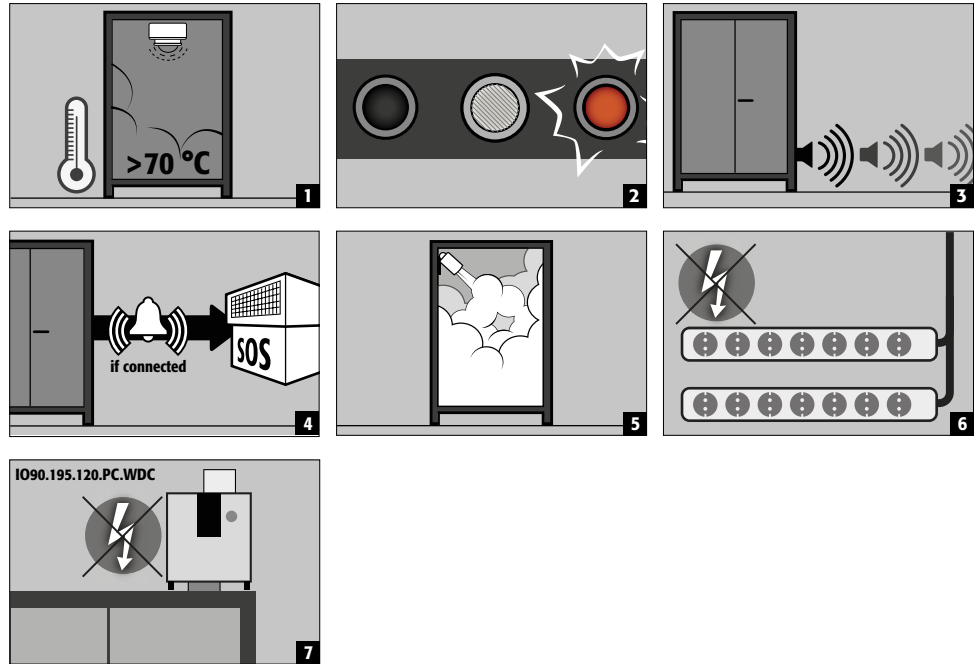

- **Actions**

Immediate visual inspection of the system by **technical personnel (e.g. fire brigade)**.
Subsequently, initiation of necessary actions.

See 12.1 for the transport of the cabinets out of the building.



NOTE:

After the fire suppression device has been triggered, the safety cabinet must be subjected to a thorough inspection so that both fire protection and CE conformity are maintained. For this purpose, the cabinet must be handed over to the main factory of asecos GmbH in Gründau, where the specialist department - depending on the degree of damage - will make an assessment of the economic efficiency and technical possibilities of a repair. The customer then receives an offer of either a repair or a replacement, which can be handed over to the responsible property insurer.

12. BATTERY FIRE - EVENT OF FIRE - DISPOSAL

12.1. FIRE INSIDE THE CABINET (BATTERY FIRE)



- For fast transport the cabinets are equipped with a transport base.
The cabinets are automatically disconnected from the mains supply in the case of transport.

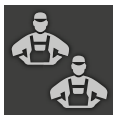

NOTE for 2-door tall cabinets

Evacuation by at least 2 persons is recommended. Only qualified personnel (e.g. fire department) may carry out transportation in the event of a fire.



CAUTION:

The doors must be locked before transport! Depending on the door heights, it may be necessary to remove the ventilation attachment beforehand. Transport may only be carried out by qualified personnel!

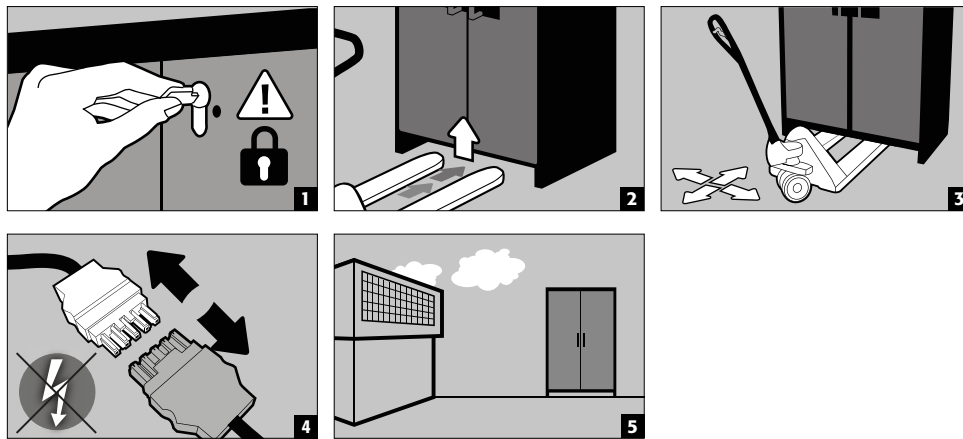

12.2. OPENING THE CABINET AFTER THE FIRE



CAUTION:
Do not open the cabinet until it has cooled down. This is 6 times the fire duration!
The cabinet may only be opened by authorised personnel (e.g. fire brigade)!
 Depending on the duration of the fire, an ignitable vapour-air mixture may have formed, therefore remove all ignition sources within a 10-metre radius around the cabinets before opening. Use only non-sparking tools! Open the cabinets with extreme caution!

12.3. DISPOSAL



The models can be disposed of once they have been dismantled and the materials sorted.

13. SAFETY CHECKS

13.1. ALL MODELS

As safety equipment the cabinets have to be checked for safety at least once per year. The next checking date can be taken from the service sticker on the outside of the door. This annual check can be carried out with the necessary care, and for securing your warranty claims in the case of fire, only by an authorised asecos employee (refer also to our service brochure regarding this).

13.2. ION-PRO-90

A necessary service is automatically indicated by the cabinet by a flashing green LED. Within the context of the annual check, the fire suppression system, smoke detector and sensors will be checked in addition to the check of all safety-related parts.

13.3. ION-CORE-90

A necessary service is indicated by service sticker on the door of the cabinet. Within the context of the annual check, all safety-related parts, the smoke detector and the alarm signalling will be checked.

13.4. ION-CORE-90: SMOKE DETECTOR MAINTENANCE



ATTENTION

In accordance with DIN 14676 the proper function of the smoke detector must be checked at least once per year.

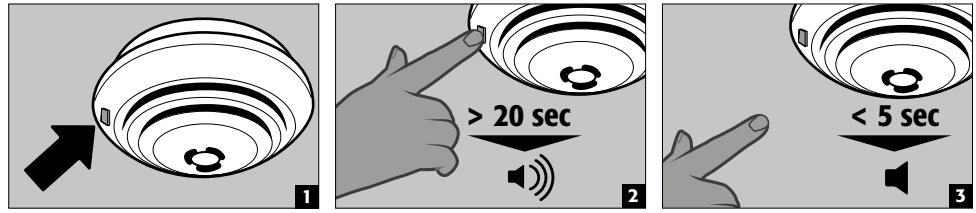

- The smoke detector is completely tested with the LED test button (fig. 1): battery function test, electronic smoke chamber test and a test of the evaluation electronics.
- After releasing, the test alarm resets itself
- Following a successful test, the alarm is silenced and the LED flashes every 45 seconds - the smoke detector is ready to operate
- If the test failed, see error and alarm overview for error analysis

Self-test

- The smoke detector carries out an automatic self-test, in which the evaluation electronics as well as the voltage and the internal resistance of the battery are checked about every 45 seconds.
- This check is signalled by a short flashing signal of the red LED.

13.5. CLEANING

The cabinets can be cleaned with a mild household cleaner and a soft cloth.

In case of damage please contact your dealer in order to have the cabinet repaired using original spare parts.

13.6. CONTACT



CONTACT:

In the case of defects or complaints about our products (within and also after the warranty period), and for requesting safety checks or taking out a service contract, please contact our service hotline on:

Tel: +44 1785 22 70-90 | info@asecos.co.uk (for great Britain and Ireland)

Tel: +49 1805 92 20 92 | service@asecos.com (international)

14. TECHNICAL DATA

ION-PRO-90		IO90.195.120.PC.WDC	IO90.195.120.PS.WDC
Type		90	90
External dimensions W x D x H		1193 x 615 x 2224 mm	1193 x 615 x 1953 mm
Internal dimensions W x D x H		1050 x 522 x 1647 mm	1050 x 522 x 1647 mm
Weight without interior equipment	kg	424	424
Distributed load	kg/m ²	531.00	531.00
Extraction air	DN	75	75
Entry width transport base	mm	1120	1120
Entry height transport base	mm	90	90
Max. shelf load (evenly distributed)	kg	75	75

Power consumption of control electronics

Power consumption in operation	W	47,5	1,5
Nominal voltage	V	230/400	230
Frequency	Hz	50/60	50/60

Total power rating of the power socket strips

		EU	CH	UK	FR/BE
Fuse (1-phase)	A	16	10	13	16
Power max. (1-phase)	kW	3,68	2,3	2,99	3,68
Fuse (3-phase)	A	3 x 16	3 x 10	3 x 13	3 x 16
Power max. (3-phase)	kW	11,04	6,9	8,97	11,04

ION-CORE-90		IO90.195.060.CC.WDC	IO90.195.060.CS.WDC	IO90.195.120.CS.WDC
Type		90	90	90
External dimensions W x D x H		599 x 615 x 1953 mm	599 x 615 x 1953 mm	1193 x 615 x 1953 mm
Internal dimensions W x D x H		450 x 522 x 1647 mm	450 x 522 x 1647 mm	1050 x 522 x 1647 mm
Weight without interior equipment	kg	265	265	424
Distributed load	kg/m ²	894.00	894.00	531.00
Extraction air	DN	75	75	75
Entry width transport base	mm	526	526	1120
Entry height transport base	mm	90	90	90
Max. shelf load (evenly distributed)	kg	25	75	75

Power consumption of control electronics

Power consumption in operation	W	
Nominal voltage	V	230/400
Frequency	Hz	

Total power rating of the power socket strips

		EU	CH	UK	FR/BE
Fuse (1-phase)	A	16	10	13	16
Power max. (1-phase)	kW	3,68	2,3	2,99	3,68
Fuse (3-phase)	A	3 x 16 ⁽¹⁾	3 x 10 ⁽¹⁾	3 x 13 ⁽¹⁾	3 x 16 ⁽¹⁾
Power max. (3-phase)	kW	7,36	4,6	5,98	7,36

(1) With this model only 2 of the 3 phases are used.

15. TECHNICAL DRAWING

15.1. ION-PRO-90

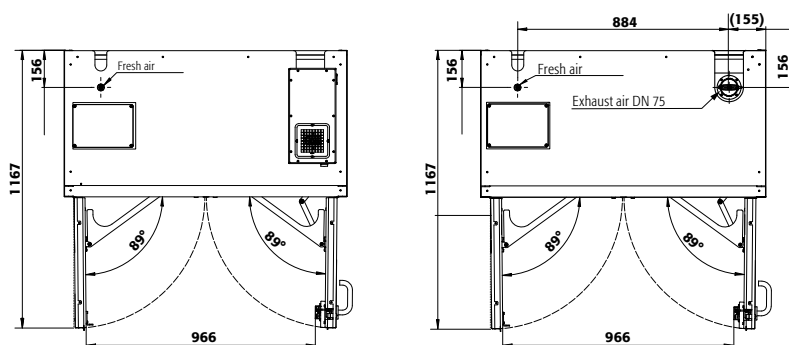

IO90.195.120.PC.WDC

IO90.195.120.PS.WDC

15.2. ION-CORE-90

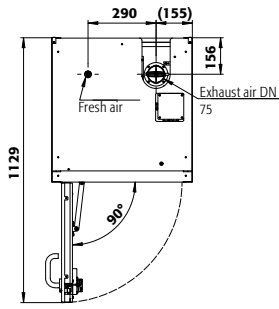

IO90.195.060.CC.WDC

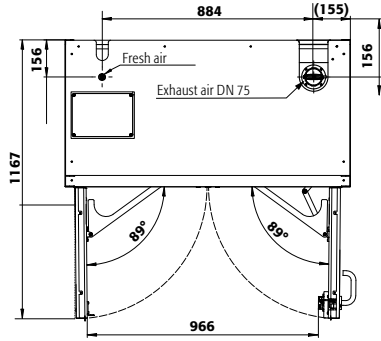

IO90.195.120.CS.WDC

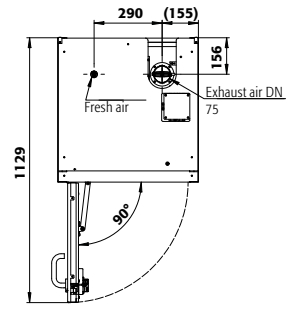

IO90.195.060.CS.WDC

